

**Plan View Elevation - Roadside Range Type S**

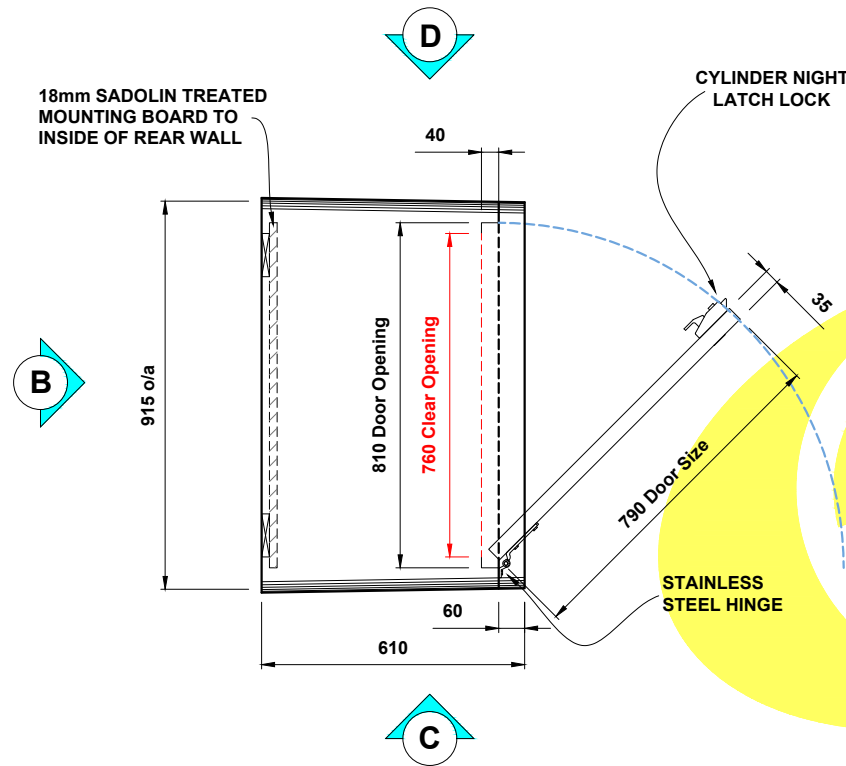

**Elevation (A) (front)**

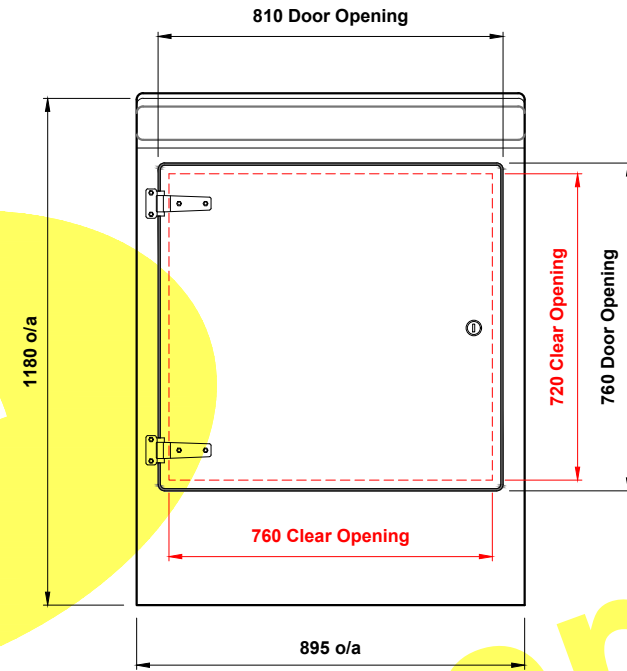

**Elevation (B) (rear)**

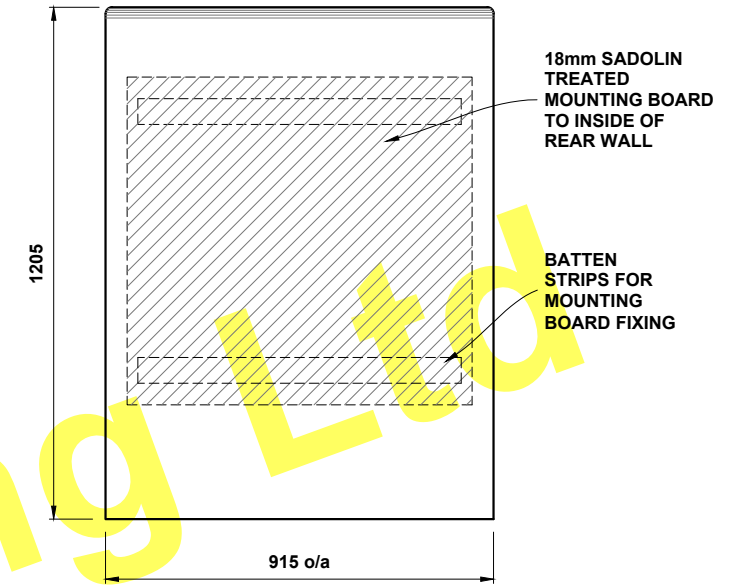

**Elevation (C) (l/h side)**

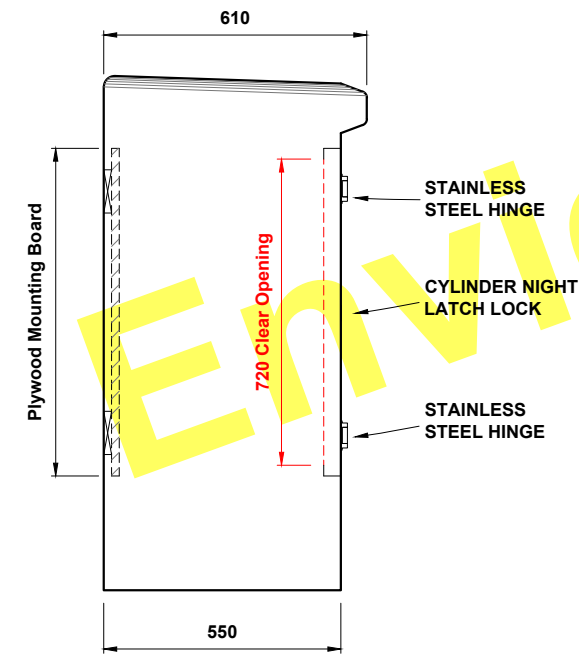

**Elevation (D) (r/h side)**

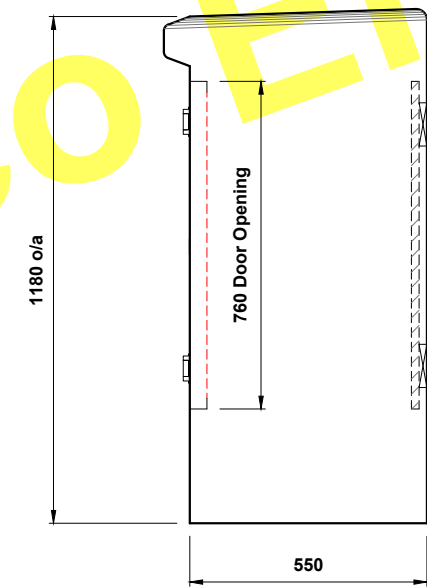

**Elevation (C) (l/h side) Door Open**

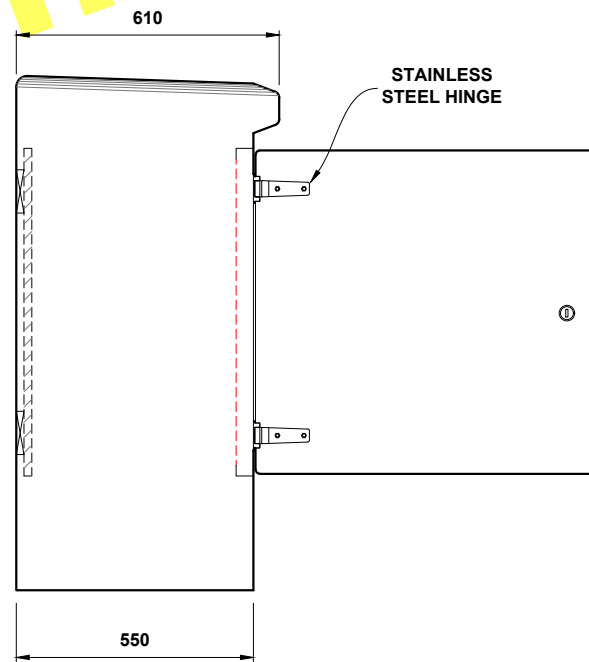

**Elevation (D) (r/h side) Door Open**

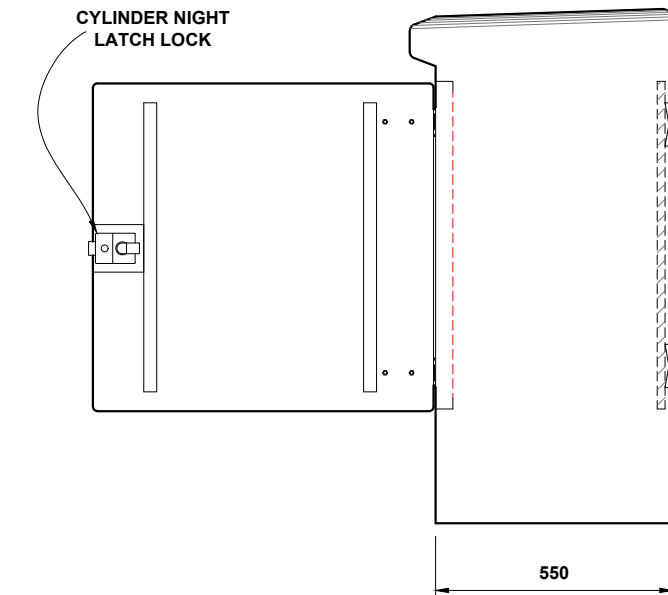

THE DRAWING AND DESIGN IS THE PROPERTY OF ENVICO ENGINEERING LTD. AND WITHOUT THE WRITTEN CONSENT OF ENVICO ENGINEERING LTD. MAY NOT BE COPIED IN WHOLE OR IN PART OR COMMUNICATED TO A THIRD PARTY OR USED FOR ANY PURPOSE.

**Envico Engineering Limited**

Tel : 01792 794 619

Fax : 01792 793 532

Nantyffin Road (South), Enterprise park, Llansamlet Swansea, SA7 9RG, South Wales.

INTERNAL WIDTH : 890mm

APPROX. WEIGHT : 50kg

GRP HOUSING : ROADSIDE RANGE TYPE S

INTERNAL DEPTH : 500mm

Date : 03/05/2019

Drawing Scale : Not To Scale

INTERNAL HEIGHT : 1135mm

Drawn By : D O'Malley

Drawing No : TYPE S

Rev :